

AD-68 BS POP
RIVETS (2/LUG).

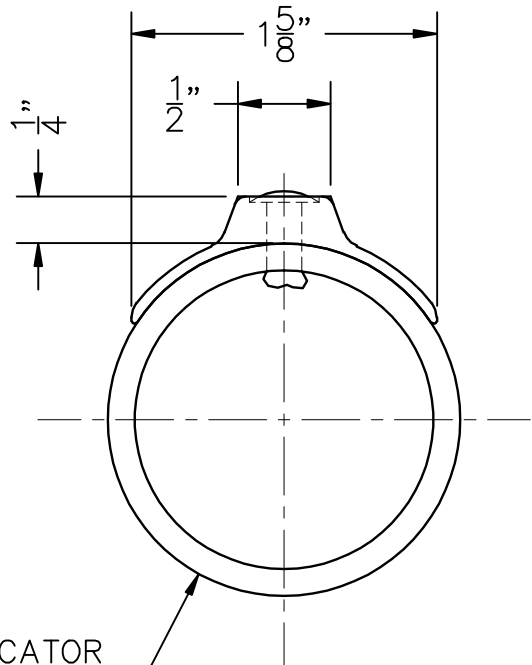

1 1/2" SKATERADICATOR
FITS 1 1/2" Sch.10, 40 OR
80 PIPE (1.90" o.d.)

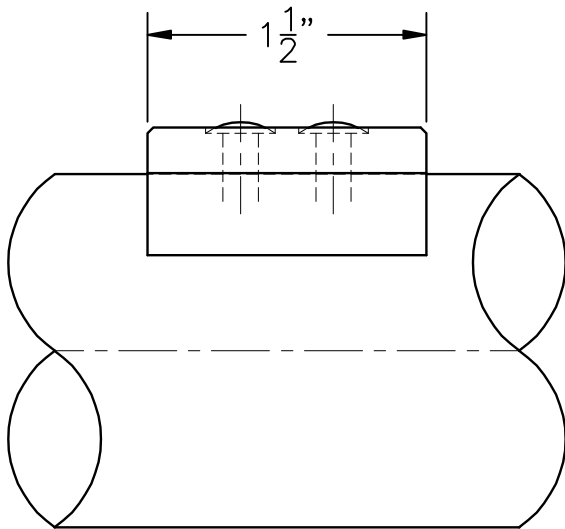
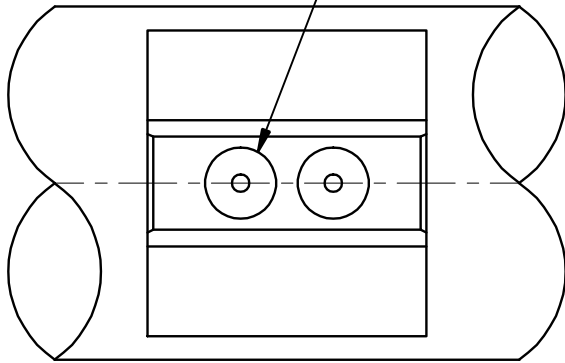

American Railing Systems, Inc.
1813 McCLELLAND AVENUE
ERIE, PA 16510
PHONE: (814) 899-7677 WEBSITE: WWW.AMERICANRAILING.COM
FAX: (814) 899-0743 EMAIL: ARS@AMERICANRAILING.COM

TITLE: 1 1/2" SKATERADICATOR

JOB NAME:

CUSTOMER:

RAIL STYLE: 1 1/2" PIPE RAIL

FINISH: CLEAR OR COLOR ANODIZED

DATE: 3-7-08 SCALE: FULL

JOB #: DWG #: 1.5 SERAD